

Purchase at [www.neutron.supply](http://www.neutron.supply)

**Neutron Supply**

255 East 17th Street, Paterson NJ 07525 Tel: 973.261.9596

E-Mail: [info@neutron.supply](mailto:info@neutron.supply) [www.neutron.supply](http://www.neutron.supply)

© 2023 Neutron Supply. All Rights Reserved

## LED PARKING GARAGE MINI CANOPY

### SPECIFICATIONS

SKU	OCF1001
Wattage	70W
Lumens	10500lm
CCT	5700k
CRI	Ra>70
LED QTY	96PCS (3030)
Input	120-277VAC@50/60Hz Max .65A
THD	<20%
Surge	L-N: 2KV I/N-PE:4KV4KV
Product ID	PHQV2GVG
IP Rating	IP65
Power Factor	>0.95
Dimmable	0-10V
Sensor	RECEPTACLE (multifunction sensor)
Efficacy	150LM/W (±10%)
IK Degree	IK08
Finish	Bronze
Replaces PSMH	320W
Warranty	5 Years
Certificates	UL/cUL, DLC 5.1 Premium

**Zhaga** BOOK18  
Multifunction DOS



### FEATURES

- Easy Installation
- Premium LED Chips
- Rugged Construction
- CRI>70
- IP IP65 Water Proof
- Low-Cost Maintenance
- Motion Sensor (Optional)
- Thermal Head Dissipation
- Beam Angle 90 Degrees
- Rebate Eligible

### APPLICATIONS

- Parking Garage Light
- Canopy Light
- Gas Station Canopy

### ACCESSORIES (SOLD SEPARATELY)



Sensor Control  
SKU: RCMF1002

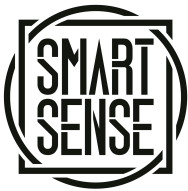

Purchase at [www.neutron.supply](http://www.neutron.supply)

**Neutron Supply**  
 255 East 17th Street, Paterson NJ 07525 Tel: 973.261.9596  
 E-Mail: [info@neutron.supply](mailto:info@neutron.supply) [www.neutron.supply](http://www.neutron.supply)  
 © 2023 Neutron Supply. All Rights Reserved

# UFO PARKING GARAGE MINI CANOPY

## DIMENSIONS

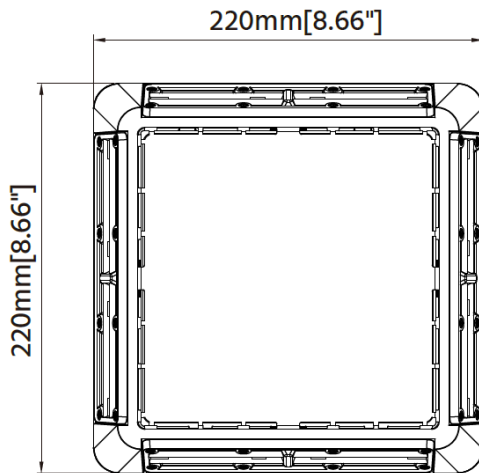
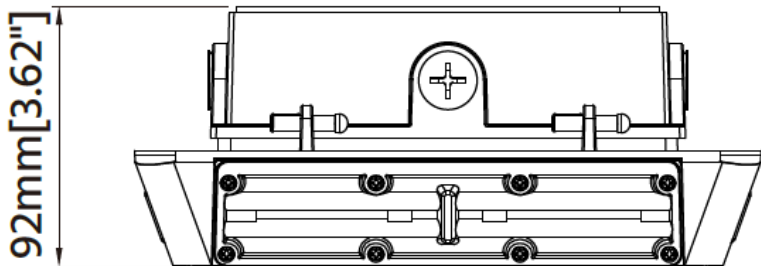

## PHOTOMETRIC

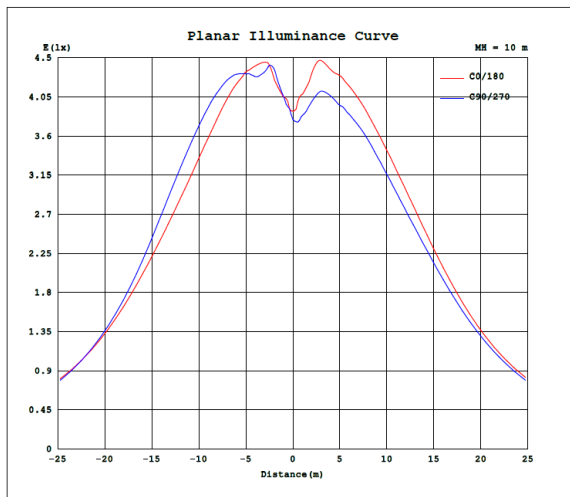
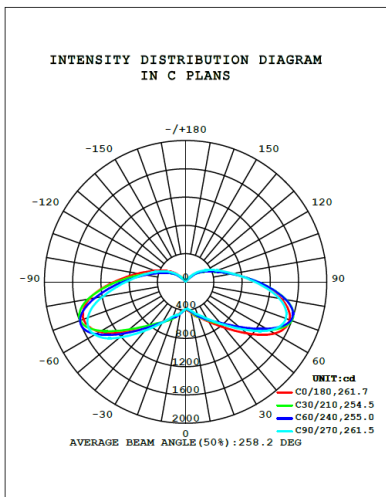

## PACKAGE

SKU / WATT	QTY BOX / CARTON	CARTON SIZE	BOX / CARTON WEIGHT
OCF1001 / 70W	4 PC CARTON	22"x11.3"x11.2"	21.38 lbs

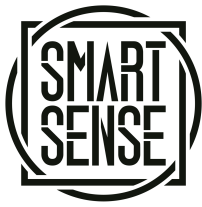

Purchase at [www.neutron.supply](http://www.neutron.supply)

# LED SENSOR REMOTE

<b>Detection Area</b>	Short press to set detection area 25% / 50% / 75% / 100% Long press (>3s) to transmit selected value
<b>Hold Time</b>	Short press to set hold time 0S / 30S / 1min / 3min / 5min / 10min / 20min / 30min Long press >3s to transmit selected value
<b>Daylight Threshold</b>	Short press to set daylight threshold 5Lux / 15Lux / disable Long press >3 to transmit selected value  When set daylight threshold to <b>disable</b> , sensor will switch on light when detect motion regardless of ambient brightness level
<b>Send</b>	Short press to transmit all selected value on remote screen
<b>Stand-By Period</b>	Short press to set standby period 0S / 30S / 1min / 3min / 5min / 10min / 20min / 30min / +∞ Long Press >3s to transmit selected value
<b>Stand-by DIM Level</b>	Short press to set standby dimmin level 10% / 20% / 30% / 50% Long Press >3s to transmit selected value
<b>Auto Mode</b>	Short press to set working mode: MD = Motion + Daylight Priority (daylight switch) / Daylight Harvesting; P = Daylight priority / Daylight Harvesting  Long press >3s to transmit selected mode  Note: MP or P is not available for all models. Please follow spec sheet of motion sensor
<b>ON / OFF</b>	When set light on, when power turn off and on again, light will be on. When set light off, when power turn off and on again, light will be on for 9 seconds and then off
<b>Motion Sensor</b>	Short Press to quit from constant on/off mode, sensor start to work (the previous setting stays in validity)
<b>DIM+ / DIM-</b>	Short press to set occupancy light level 50%-100% in MD mode; Set target lux level in MP (Motion+Daylight Harvesting) mode; Dim level will change 5% each time button is pressed
<b>Reset</b>	Detection Area: 100%; Hold Time: 30min Daylight Sensor: Disable; Stand-by Period: 30min; Stand-by Dim Level: 30%
<b>Quick Settings</b>	Option 1. Short press to show setting configuration, long press >3s to save this configuration. Press "send" to transmit selected quicksetting  Option 2. Short press to show the setting configuration, long press>3s to save this configuration. Press "send" to transmit selected quicksetting
<b>H/L</b>	Short press to set high <b>H</b> sensitivity (open application; <b>L</b> low sensitivity (applied in reflection surface around area)
<b>S</b>	N/A

*\*Sensor Control Sold Separately*



**SKU: RCMF1002**

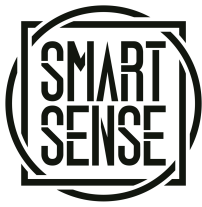

**Neutron Supply**

255 East 17th Street, Paterson NJ 07525 Tel: 973.261.9596

E-Mail: info@neutron.supply www.neutron.supply

© 2023 Neutron Supply. All Rights Reserved

Purchase at [www.neutron.supply](http://www.neutron.supply)

# DESIGNLIGHTS CONSORTIUM



<b>Classification</b>	Premium
<b>Primary Use</b>	Parking Garage Luminaires
<b>Reported Input Wattage</b>	71 W
<b>Reported Light Output</b>	11305 lm
<b>Reported CCT</b>	5700 K
<b>Reported CRI (Ra)</b>	83
<b>Product ID</b>	PHQV2GVG
<b>DLC Family Code</b>	JJJOYD
<b>Listing Status</b>	Listed
<b>Date Qualified</b>	12-29-21

<b>Project Name:</b>
<b>Type:</b>
<b>Catalog Number:</b>
<b>Voltage:</b>
<b>Approved By:</b>
<b>Date:</b>